

# INSTRUCTION MANUAL

## Magna-Spot® Studwelder Dent Repair Kit

Models JO1000, JO1500, JO2000

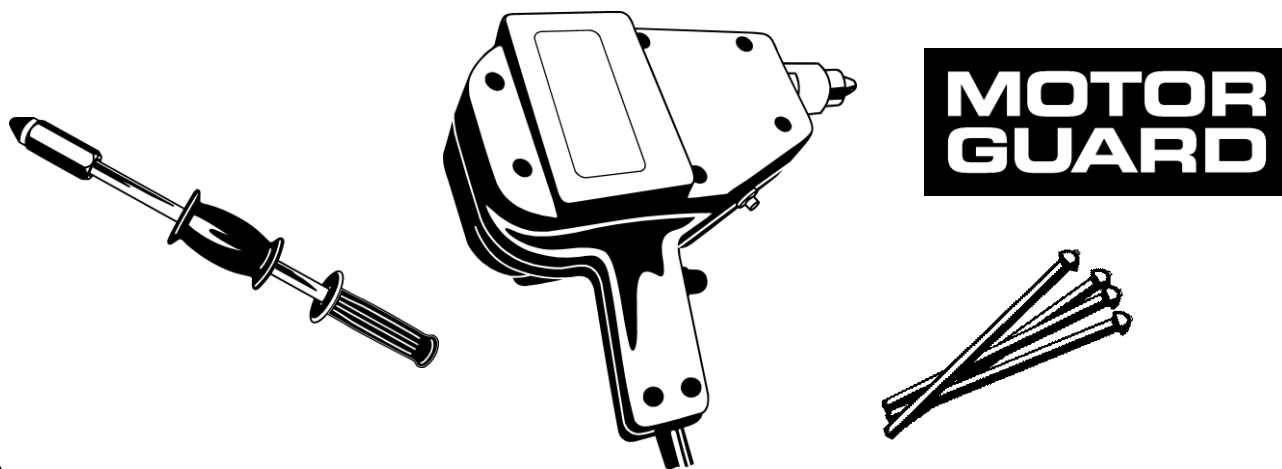

### WARNING:

Read and understand all instructions before attempting to operate tool.

Failure to follow instructions may result in electric shock, fire and/or serious personal injury.

## IMPORTANT SAFETY INSTRUCTIONS



**To reduce the risk of serious injury and/or property damage, observe all warnings and instructions while operating the welder.** Keep work area clean and well lit. Maintain tool in top condition and obtain service from manufacturer if tool malfunctions. Use only accessories and replacement parts that are provided by the manufacturer.



**To reduce the risk of electrical shock:** Do not expose welder to rain or wet conditions. Water entering tool will increase the risk of electrical shock. Unplug welder when not in use. Do not operate welder with any portion of the housing removed. Disconnect welder from power supply before servicing any part of the welder. Failure to follow these instructions will increase the risk of electrical shock.



**Do not abuse power cord.** Never use the power cord for carrying, pulling or unplugging the welder. Keep power cord away from heat, sharp edges and moving parts. Replace power cord immediately if it becomes damaged. Damaged cords increase the risk of electrical shock.



**This welder must be connected to a properly grounded outlet** installed in accordance with all local codes and ordinances. Never remove the grounding prong or modify the plug in any way. Do not use adapter plugs. Consult an electrician if you are in any doubt as to whether the plug is properly grounded. Avoid bodily contact with grounded surfaces.



**Do not operate tool in explosive atmospheres,** such as in the presence of flammable liquids, gases or dust. Welders create sparks which may ignite dust or fumes. Use in well ventilated areas only. Welders generate heat which can ignite surrounding materials causing fires. Do not use welder on body panels containing insulating material which may be ignited by the heat.



**Always wear proper personal protection when operating welder.** Proper eye protection is required to reduce the risk of eye injury from sparks and molten metal. Adequate gloves and clothing are required to reduce the risk of burns. Allow parts to cool before handling.

## SAVE THESE INSTRUCTIONS

Model Number: \_\_\_\_\_ Serial Number: \_\_\_\_\_ Date Purchased: \_\_\_\_\_

IF YOU HAVE ANY QUESTIONS ABOUT THE OPERATION OF PRODUCT CALL TOLL FREE  
800-227-2822

8:00 am to 5:00 pm - Pacific Time - Monday through Friday

## PREPARING TOOL FOR USE

Read and understand all warnings and instructions prior to use.

For 120V operation in the US and Canada, a three prong plug is provided. For units rated at 240V, a field supplied, approved plug must be installed by the user. Consult an electrician for the proper connector. Supply circuit receptacle, conductors, fuses and circuit breakers must be capable of handling a 15 ampere load. Welder should be the only device connected to the circuit being used.

An adequate power supply is required for proper welding operation. The welder is provided with a 9 foot power cord which should be suitable for most work stations. If an extension cord is required, it must be a three wire grounded cord with a minimum of 12 AWG conductors. Cord must not exceed 10 feet in length. Reduced welding capacity will result from the use of undersized or long extension cords.

## GENERAL WELDING PROCEDURE

Select proper electrode tip for work to be performed. Insert electrode tip into welder, tapered end first, and rotate slightly for a tight fit. **(Fig. 1)** Use opposite procedure to remove electrode tip. A box end wrench can be used to twist electrode slightly to loosen.

Proper welding requires that the surface to be welded be clean, bare metal free of paint, primer, oil and dust. Grind area to be welded to expose bright metal approximately one inch all around area to be welded.

Insert pin or rivet to be welded in electrode tip and place tip of electrode against exposed metal. Press until outer electrode tube is in full contact with bare metal. Hold welder in this position and depress trigger for one-half to one second. A proper weld is achieved when the heat affected area around the weld is approximately 1/4" in diameter. To prevent sparking, do not pull electrode tube back until trigger is released.

Do not hold trigger for more than one second as burn through may result. Operating the welder beyond its duty cycle (one second on, 60 times per hour) will result in tripping of the circuit breaker. Allow welder to cool for one minute before resetting the circuit breaker and resuming welding.

## DENT REMOVAL WITH MAGNA-PINS®

Prepare metal at damaged area per above instructions. Insert Magna-Pin® electrode tip into welder followed by a Magna-Pin®. **(Fig. 2)** Use 2.0mm pins for dent removal on lightweight body panels and 2.5mm pins for posts and heavier panels. Weld pin as instructed above.

Magna® Slide Hammer, T-Puller or Clamp may be used for dent repair depending on extent of damage and panel thickness. **(Fig. 3)** Grip pins 1/2 inch from surface and apply steady pressure while working dent with appropriate body hammer. Slide hammer action may be used for more extreme pulling.

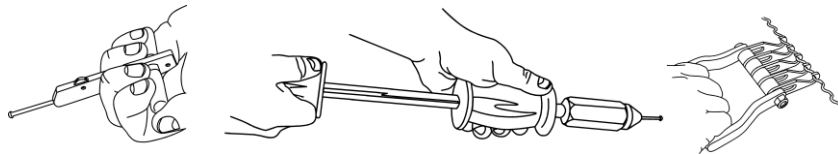

Figure 3

Rotate head of Slide Hammer clockwise 1/4 turn to grip pins, opposite direction to release. Rotate knurled wheel of T-Puller back to lock pin for pulling. To release, push puller forward while rotating wheel forward. Electrode Extension and Adapter Tube may be used for welding in difficult areas and to place pins close together for more effective pulling with clamps. Rotate wing-nut on Magna-Clamp® clockwise to tighten. Strike end of hook with hammer to release then loosen nut.

Use side-cutting wire cutters to remove studs after repair. Rock pin and twist slightly until it breaks off.

## DENT REMOVAL WITH MAGNA-WIRE®

Prepare metal at damaged area per above instructions. Slide adapter over outer electrode tube. Tap into place as required to seat firmly. Insert Magna-Wire® electrode tip into welder. Use 16 Ga. wire for dent removal on lightweight body panels and 12 Ga. wire on heavier panels. Place wire between body panel and tip of electrode as shown. **(Fig. 4)** Weld as instructed above. Weld wire at each contact point or at alternating points as required. Take care not to burn through wire by applying too much heat.

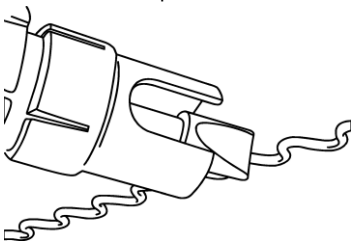

Figure 4

Use Magna-Claw® or other device to work crease out, starting at one end and working to the other. Magna-Claw® fingers provide self-leveling action by pulling deeper recesses first until dent is removed.

Use pliers to remove wire by rocking back and forth at weld points.

## TRIM RIVET INSTALLATION

Prepare metal at area of rivet installation per above instructions. Insert trim rivet electrode tip into welder followed by trim rivet. **(Fig. 5)** Rivet will be held by magnet in electrode. Weld as instructed above.

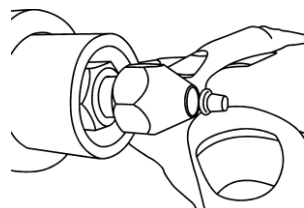

Figure 5

## SHRINKING STRESSED METAL

Shrinking electrode tip can be used to raise low areas or shrink high spots. Prepare area around damage as instructed above. Insert shrinking electrode tip into welder.

To remove low spots, place rounded tip of electrode at several points around spot and depress trigger for one-half second two or three times. Be sure outer electrode tube is in contact with bare metal while doing this. Immediately apply cold blocking or wet cloth to area to shrink it back to its original shape.

To remove high spots and repair pin weld points, place rounded tip of electrode directly on high spot and depress trigger for one-half second. Repeat as needed. A gentle hammer on heated metal may be used for heavier damage.

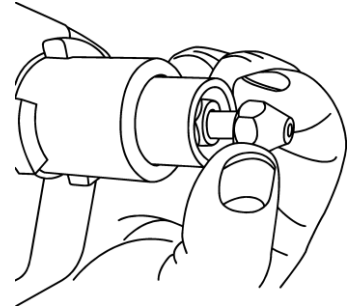

Figure 1

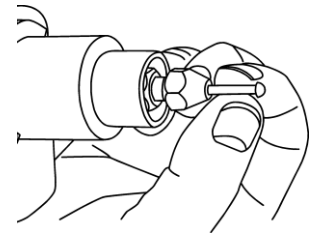

Figure 2

## MAINTENANCE

Disconnect welder from power source and allow all parts to cool before performing service or repair.

Inspect power cord at each use for signs of wear or damage. Do not operate welder if wear or breaks in insulation or wire are present. Obtain repair service for damaged power cord.

Clean electrode tips and electrode tube periodically. Steel wool or a fine wire brush can be used to remove oxidation and carbon from electrode surfaces. Replace electrodes when they become excessively worn.

Inspect case, switch and circuit breaker periodically and obtain service if damage is present.

## TROUBLESHOOTING

Troubleshooting of internal parts must be performed by qualified persons. The following chart is intended to provide remedies for simple problems that may be encountered when using the welder. For malfunctions not covered by this chart, contact place of purchase or manufacturer for service.

Trouble	Possible Cause	Remedy
No Output	Open Line Fuse or Tripped Line Circuit Breaker	Check for power at outlet. Replace fuse or reset circuit breaker.
	Tripped Circuit Breaker On Welder Case	Wait for welder to cool. Reset circuit breaker on case.
	Weld Circuit Not Complete	Ensure that electrode tube is in full contact with clean base metal for proper grounding.
Low Output Poor Weld Quality Pins Won't Hold	Weld Time Too Short	Increase weld time to achieve proper weld.
	Work Surface Not Clean	Remove all paint, rust, dust and oil to obtain a dry bright surface.
	Base Metal Too Thick	Welder is designed for use on sheet steel of the type and thickness used in automobile construction.
	Electrode Tip or Electrode Tube not Clean	Remove all carbon and oxidation from electrode tip and electrode tube to expose clean copper.
	Pins Corroded / Not Clean	Clean pins to remove contaminants and let dry. Sand a small area on tip of pin to expose clean metal.
	Improperly Sized Extension Cord	Do not use an extension cord if at all possible. Check instructions for recommended gauge and cord length.
Burn Through at Point of Weld	Weld Time Too Long	Decrease weld time to prevent burn through.
	Base Metal Too Thin.	Check instructions for proper material and thickness.

## ACCESSORIES

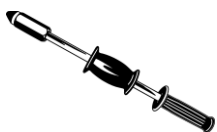

### MAGNA-SLIDE HAMMER®

Heavy duty construction with quick release chuck to grip pins firmly without slipping. Cast iron slide weight and comfortable vinyl grip. (J20003)

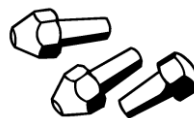

### ELECTRODE TIPS

Machined from high quality copper for highest conductivity. Covers all applications from Magna-Pins® (J20007) and Trim Rivets (J20009) to Shrinking (J20006).

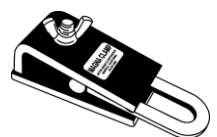

### MAGNA-CLAMP®

Constructed of heat-treated, hardened steel with quick wing-nut adjustment. Clamps on to multiple pins and makes quick work of pulling on posts and other heavy sections. (J20016)



### ELECTRODE ADAPTERS

Adapter Tube (J20022) extends tip of welder for use with Magna-Wire® Electrode Tip (J20020) or Electrode Extension (J20011) for tight spots or side by side pin welding.

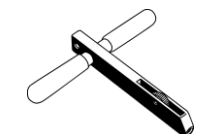

### MAGNA T-PULLER®

A compact tool for small damage repair on lightweight metal. Convenient thumb wheel locking and a firm grip. Hand pulling reduces over-pull for detail work. (J20017)



### STRIKER-TIP® DRAW PINS & TRIM RIVETS

Copper coated steel is soft for easy flexing and grinding but delivers a 500 lb. pull. In two sizes; 2.0 mm (J20014) 2.5 mm (J20015). Trim rivets (J20012) for repair of all molding.



### MAGNA-CLAW®

For use with Magna-Wire®. Five finger claw features all welded construction and self-leveling design to pull low spots first. Excellent for creases. (J20037)

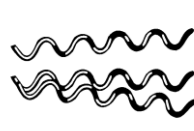

### MAGNA-WIRE®

Corrugated wire is copper coated steel. Use to pull out long creases evenly with the Magna-Claw®. In two sizes; 16 Ga. (J20024) and 12 Ga. (J20025)

## REPLACEMENT PARTS

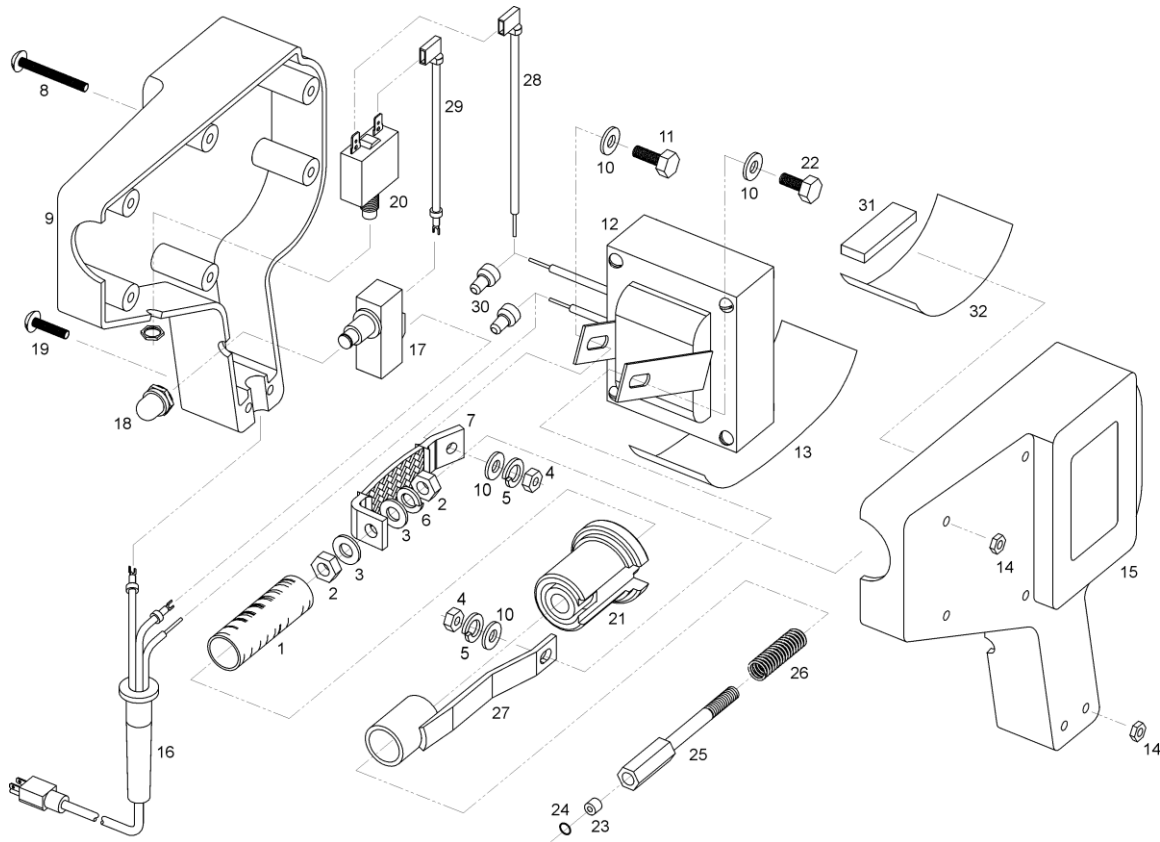

ITEM	DESCRIPTION	QTY	PART NO.	ORDER NO.	ITEM	DESCRIPTION	QTY	PART NO.	ORDER NO.
1	INSULATOR SLEEVE	1	JP1030	52410	17	TRIGGER SWITCH	1	JP1010	52310
2	HEX NUT 5/16-18 BRASS	2	JP1020	44025	18	BOOT, TRIGGER SWITCH	1	JP1039	52305
3	FLAT WASHER, SAE 5/16 BRASS	2	JP1021	44270	19	MACHINE SCREW, SLOTTED 10/32 X 7/8	2	JP1007	44165
4	HEX NUT 1/4-20	2		44015	20	CIRCUIT BREAKER 1000/1500 SERIES 120V	1	JP10091	52356
5	LOCK WASHER, SPLIT 1/4	2		44345		CIRCUIT BREAKER 1000/1500 SERIES 240V	1	JP10093	52351
6	LOCK WASHER, SPLIT 5/16	1		44350		CIRCUIT BREAKER 2000 SERIES 120V	1	JP10092	52360
7	BRAIDED STRAP	1	JP1029	52205	21	INSULATOR, ELECTRODE TUBE	1	JP1013	22282
8	MACHINE SCREW, SLOTTED 10-32 X 1-3/4	6	JP1005	44170	22	CAP SCREW, HEX 1/4-20 X 5/8 GR5	1		44070
9	CASE, RIGHT-HAND	1			23	RETAINER, MPS SYSTEM	1	JP1017	22550
10	FLAT WASHER, SAE 1/4	4		44260	24	WASHER, MPS SYSTEM	1	JP1018	44285
11	CAP SCREW, HEX 1/4-20 X 3/4 GR5	1		44072	25	SLIDING ELECTRODE (INCLUDES RETAINER)	1	JP1011	11122
12	TRANSFORMER 1000/1500 SERIES 120V	1	JP10081	52430	26	SPRING, SLIDING ELECTRODE	1	JP1015	61280
	TRANSFORMER 1000/1500 SERIES 240V	1	JP10083	52433	27	ELECTRODE TUBE ASSEMBLY	1	JP1016	12205
	TRANSFORMER 2000 SERIES 120V	1	JP10082	52440	28	WIRE ASSEMBLY, BARE	1	JP1041	52210
13	INSULATOR, TRANSFORMER	1	JP1028	52405	29	WIRE ASSEMBLY, FORK	1	JP1040	52215
14	HEX NUT 10-32	8	JP1006	44010	30	TERMINAL, CLOSED END	2	JP1036	52055
15	CASE, LEFT-HAND	1			31	MAGNET, MPS CASE	1	JP1019	95382
16	POWER CORD	1	JP1000	52010	32	INSULATOR, MAGNET	1	JP1031	52407

### FIVE YEAR LIMITED WARRANTY

Motor Guard Corporation assumes the responsibility of providing products that are free from defects in workmanship and material. Should a product fail due to a defect in workmanship or material, Motor Guard Corporation will repair or, at its option, replace the product without charge, other than the transportation charges, provided that the product is returned to the factory, transportation prepaid, within **Five (5) Years** of the date of purchase. Please contact Motor Guard Corporation for return authorization and shipping instructions.

This limited warranty does not cover normal wear and tear or damage to the product due to neglect, misuse or accident, nor does it cover any loss, damage or expense, either direct, indirect or consequential, arising from the non-function of this product.

See enclosed warranty card for coverage details and instructions for obtaining warranty service.

### OBTAINING SERVICE

To assure product safety and reliability, repairs, maintenance and adjustments should be performed by authorized service centers using replacement parts provided by the manufacturer. To obtain service, return tool to place of purchase or contact the manufacturer directly:

**Motor Guard Corporation**  
 580 Carnegie Street  
 Manteca, CA 95337  
 U.S.A.  
 Toll Free: (800) 227-2822  
 info@motorguard.com  
 Hours: Mon-Fri 8:00 am to 5:00 pm PST