

"SCA 1" ISOCOLOR

VISUAL HEADLAMP ALIGNMENT SYSTEM

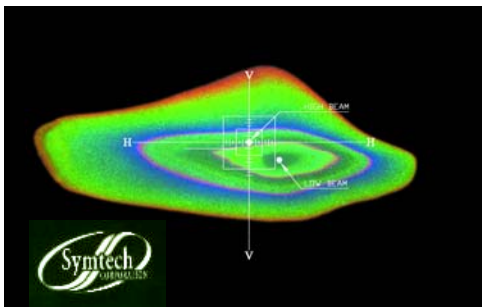

**ASSEMBLY
OPERATION
CALIBRATION**



*524 S.E. Transport Drive
Lees Summit, MO 64081*

*888-884-8182
816-525-9263 FAX: 816-525-9283
www.symtechcorp.net*

INDEX

1. GENERAL *Pg. 3*

- 1.1 “SCA 1 ISOCOLOR” INTRODUCTION
- 1.2 SYSTEM COMPONENTS
- 1.3 LASER WARNING
- 1.4 WARNING, EXPOSURE TO DIRECT SUNLIGHT

2. ASSEMBLY *Pg. 4*

- 2.1 BASE / WHEEL ATTACHMENT
- 2.2 MAST / GLIDE PLATE / ROTATIONAL MAST MOUNT
- 2.3 OPTICAL ALIGNMENT HEAD
- 2.4 SIGHTING UNIT
- 2.5 SIGHTING UNIT *CALIBRATION*
- 2.6 FLOOR SLOPE LASER

3. OPERATION *Pg. 6*

- 3.1 ALIGNMENT BAY(S) PREPARATION
- 3.2 FLOOR SLOPE MEASUREMENT
- 3.3 VEHICLE PREPARATION, Prior to Alignment

4. HEADLAMP ALIGNMENT *PG. 7*

- 4.1 ALIGNMENT of OPTICAL HEAD TO VEHICLE
- 4.2 CENTERING on the HEADLAMP
- 4.3 SELECTING HEADLAMP PATTERN
- 4.4 ALIGNMENT of HEADLAMP PROCEDURE

5. LASER CALIBRATION / MAINTENANCE *Pg. 8*

- 5.1 LASER CALIBRATION
- 5.2 MAINTENANCE

6. FREQUENTLY ASKED QUESTIONS *Pg. 9*

WARRANTY *Pg. 10*

CUSTOMER SERVICE
888-884-8182

1. GENERAL

1.1 INTRODUCTION

The Model "SCA 1 ISOColor" Visual Headlamp Alignment System is an economical optical alignment tool that functions under the same principle for accuracy and dependability of an aiming screen, with the added benefit of Symtech Corporation's "ISOColor" technology, without the excessive use of valuable shop space and the confusion of vertical and horizontal lamp placement. System design and operation has been engineered with the technician in mind. The "SCA 1" features "ISOColor" technology that facilitates headlamp alignment, with profitability and customer satisfaction as the end result.

The Model "SCA 1" is designed, manufactured and serviced by Symtech Corporation, Lees Summit, Missouri, the industry leader in headlamp alignment technology to the service and body repair industries, the architect of the Model "LCA 2 EZ" Visual, "CVA 3 EZ ISOColor" Visual and the "HBA 5" Electronic Headlamp Alignment systems along with the "AIM 200" Headlamp Intensity meter.

We are confident that the "SCA 1 ISOColor" will provide you with years of exceptional service. Thank you for selecting a Symtech "Safety by Design" product to address your headlamp alignment needs.

1.2 SYSTEM COMPONENTS

- Small Parts Package**
- 2 Large Nylon Washers
 - 2 $\frac{5}{16}$ " Nylon Washers
 - 2 $\frac{1}{4}$ " x $\frac{1}{8}$ " (WHITE)Nylon Spacers
 - 2 $\frac{1}{4}$ " x $\frac{3}{16}$ " (BLACK)Nylon Spacers
 - 2 $\frac{5}{16}$ " Self-Locking Nuts
 - 4 $\frac{1}{4}$ " x 20 Machine Screws
 - 1 $\frac{3}{8}$ " Self Locking Nut
 - 1 $\frac{3}{8}$ " Flat Washer

- Large Parts Package**
- 2 $\frac{5}{16}$ " x 5 $\frac{1}{2}$ " Carriage Bolts
 - 1 Floor Slope Handle
 - 2 Wheels
 - 1 Wheel w/Floor Slope Eccentric
 - 1 3" Rotational Bearing

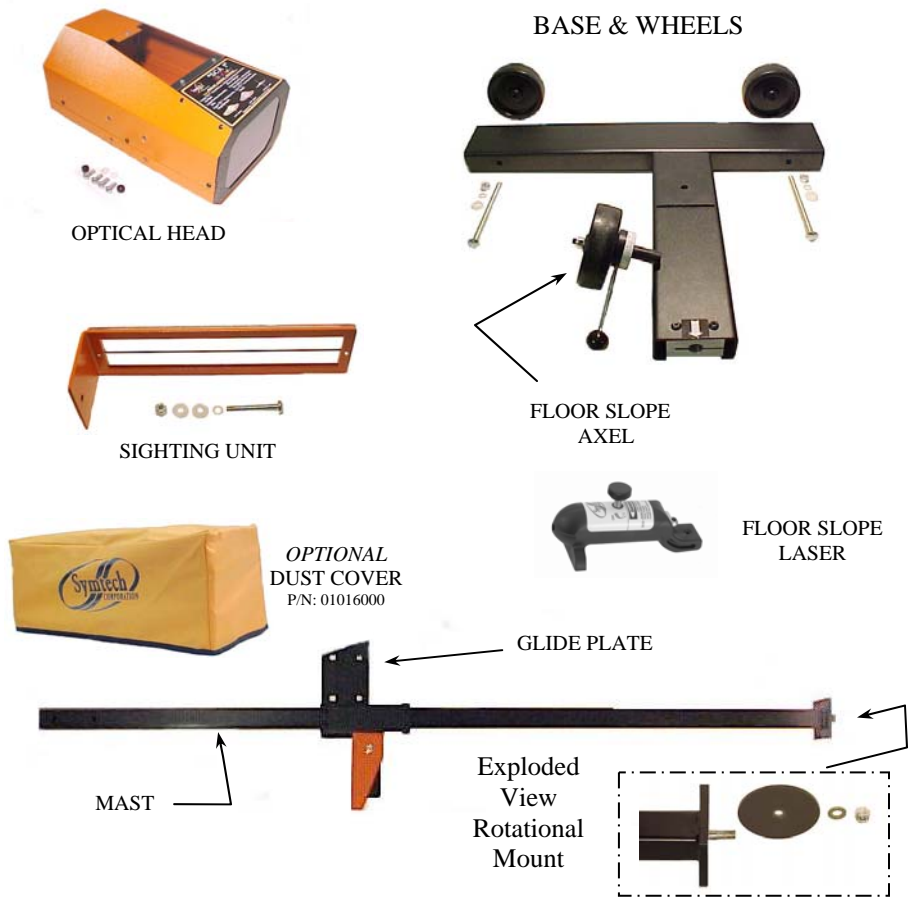

1.3 LASER WARNING

AVOID LOOKING DIRECTLY INTO LASER LIGHT – POSSIBLE EYE INJURY CAN OCCUR.



1.4 WARNING, EXPOSURE TO DIRECT SUNLIGHT

DO NOT PLACE OR POSITION "SCA 1" SO THAT DIRECT SUNLIGHT ENTERS FRONT LENS. DOING SO WILL CAUSE DAMAGE TO ISOColor SCREEN AND VOID WARRANTY. Front lens acts like an enlarged magnifying glass which will concentrate direct sunlight into a destructive high intensity beam on the aim screen.

2. ASSEMBLY

Inspect all components of the **SCA 1 ISOColor** system to assure that no damage has occurred during shipment, compare contents of package with that of the exploded view to make sure that no component has been inadvertently left out of packaging. If a component is missing, contact our customer service department at 888-884-8182 for an immediate replacement.

2.1 BASE / WHEEL ATTACHMENT

Place base of system on floor, or table with channel facing downward.

Insert a $\frac{5}{16}$ " x $5\frac{1}{2}$ " carriage bolt into each of the holes noted, making sure that the square carriage bolt head seats securely into the square hole placement.

Complete wheel assembly by placing in order a large nylon washer, wheel, small nylon washer and self-locking $\frac{5}{16}$ " nut on carriage bolt.

Tighten self-locking nut snug against wheel, but not so tight as to hinder free wheel movement.

Insert floor slope eccentric and wheel into mounting block on base (rear wheel). Tighten friction bolt until floor slope eccentric can be moved, but not loose enough to move by itself.

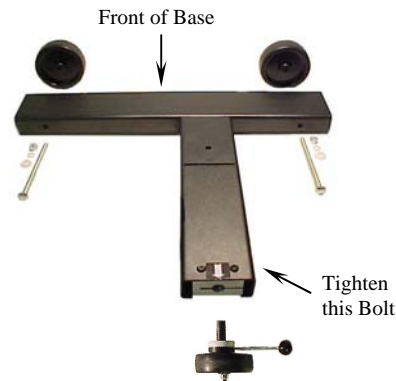

2.2 MAST / GLIDE PLATE / ROTATIONAL MAST MOUNT

The Mast and Glide Plate are packaged as an assembly.

Place rotation bearing over mast stud and insert rotational mast stud into base. Secure mast to base with $\frac{3}{8}$ " flat washer and $\frac{3}{8}$ " self-locking nut. Tighten nut securely then back-off $\frac{1}{8}$ turn, or until mast rotates freely with minor resistance.

Move glide plate up and down the mast through its full motion, by depressing handle.

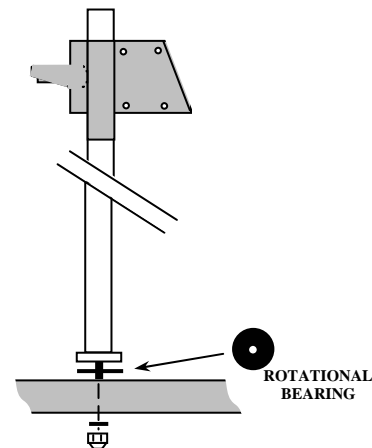

2.3 OPTICAL ALIGNMENT HEAD

Remove optical alignment head from shipping carton. Inspect for any damage that may have occurred during shipment i.e. lens, case, etc..

Attach optical alignment head to the mast glide plate by aligning mounting holes of glide plate with the holes in the optical head. Insert $\frac{1}{4}$ " x 20 x $\frac{3}{4}$ " phillips machine screw through glide plate, place a $\frac{1}{4}$ " x $\frac{1}{8}$ " (**WHITE**) nylon spacer on each upper attachment screw, place a $\frac{1}{4}$ " x $\frac{3}{16}$ " (**BLACK**) nylon spacer on each lower attachment screw and tighten securely.

Remove protective paper covering from viewing window on top of optical head.

Move optical head through the full range of movement to assure of smooth operation.

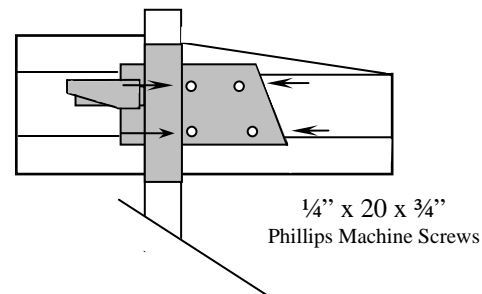

2.4 SIGHTING UNIT

Sighting unit is the "L" bracket assembly enclosed in the accessories box.

NOTE: Mount sighting unit so that unit is located directly over the optical head.

Insert the $\frac{5}{16}$ " x 2.5" phillips head machine screw with thin $\frac{5}{16}$ " nylon washer into the sighting unit.

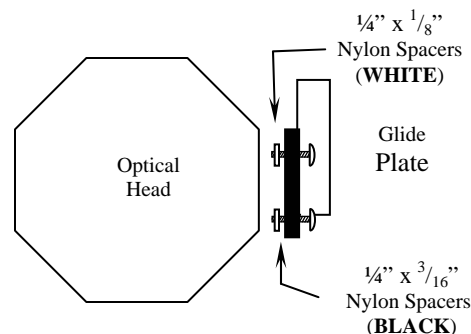

Place a thick nylon bushing on the screw and insert screw through the holes provided at the top of the mast, place a thick nylon bushing on screw and self-locking nut.

Tighten to a tension that allows for movement of sighting unit, but provides sufficient friction to hold unit in place when unattended.

NOTE: The mast has two sight unit mounting positions, mount in the position that is most comfortable for the technician to sight through

Sighting unit must be calibrated to the optical head prior to alignment of headlamps.



2.5 SIGHTING UNIT CALIBRATION

Calibration of sighting unit must be performed prior to alignment of headlamps.

Raise optical head of **SCA 1 ISOColor** to the approximate center of mast.

Turn the sighting unit until you can see the front edge of the optical head while looking through the sighting unit lens. Line on lens should line up with the front edge of the optical head.

If line does not line up with the front edge of optical head, loosen the thumbscrews on the lens and move the lens into alignment. Tighten thumbscrews.

It is important that periodical checking of calibration of the sighting unit be performed, to assure proper calibration.

NOTE: When technicians of differing heights are using the **SCA 1 ISOColor** and the sighting unit is relocated to the optional mounting position for better viewing, the sight unit must be checked for calibration and adjustment made accordingly.

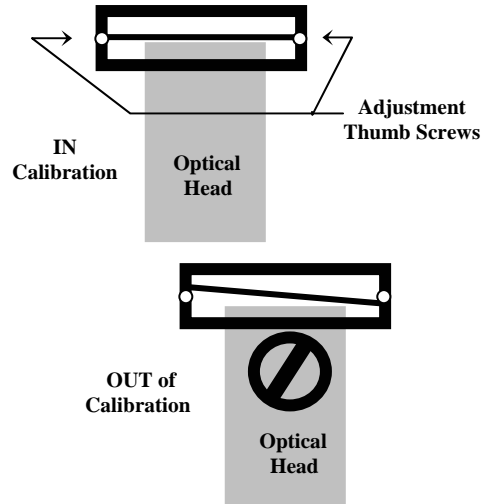

2.6 FLOOR SLOPE LASER

The floor slope laser assembly is factory calibrated, **DO NOT** turn the level adjustment set screw.

The laser is used for floor slope measurement only. Remove laser after floor slope measurements have been recorded.

Remove floor slope laser from packaging and insert front fixture placement pin into hole on top and at front of the rear area of the optical head, also there is an indentation provided for the height adjustment screw to rest within.

Activate the laser by turning ON/OFF knob clockwise (CAUTION: Excessive turning may damage laser ON/OFF mechanism) to assure of functionality, turn off laser. No further adjustment is required.

NOTE: Should calibration of the laser become necessary in the future, Refer to "LASER CALIBRATION". Calibration, Section 5.1, Pg. 9.

Laser Battery Replacement

Unscrew back of laser and replace batteries with three (3), **LR 44** button batteries or equivalent. Reverse process for assembly.

After battery replacement, CALIBRATION COULD BE REQUIRED.

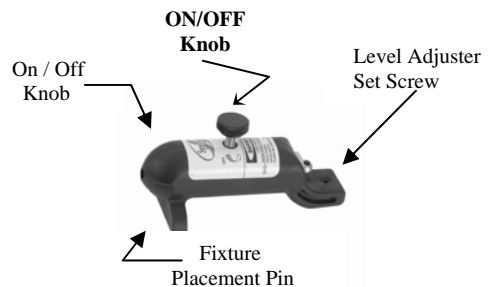

3. OPERATION PROCEDURES

3.1 PREPARATION, ALIGNMENT BAY(S)

Prior to any headlamp alignment using the **SCA 1 ISOColor**, the floor slope of the bay, or bays must be determined, this is done by using the floor slope laser assembly and noting the position of the rear floor slope wheel.

If the correct floor slope of the bay is not adjusted prior to any headlamp alignment, the technician will align the headlamps in a higher, or lower position than what is correct. The **SCA 1 ISOColor** must be on the same plain as the vehicle that is to be aligned, if the vehicle is positioned on a floor that has an upward slope running from fore to aft of vehicle, then the **SCA 1 ISOColor** must be adjusted to have the same slope.

3.2 FLOOR SLOPE MEASUREMENT

Tool Required: **Tape Measure** or **Ruler**

Move the **SCA 1 ISOColor** to the service bay to be used for headlamp alignment and place the **SCA 1 ISOColor** at the front of the vehicle, off to one side. If multiple bays are to be used, procedure for determining floor slope will need to be performed in each bay and recorded.

Lower the optical head to the bottom of the mast. Adjust optical head by rotating eccentric wheel at rear of base until level vial registers level. Turn the laser on with the thumbscrew on the front of the laser assembly.

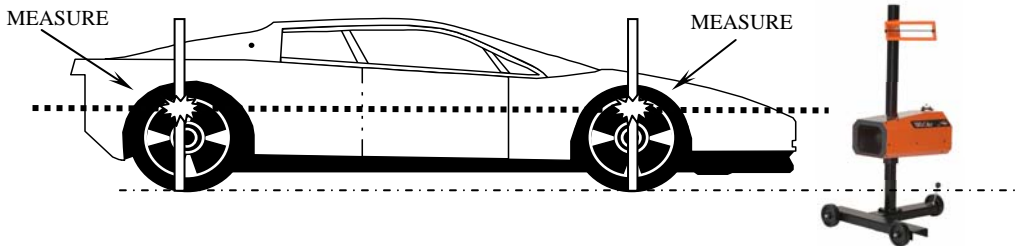

At the center point of the front wheel of the vehicle measure the distance from the floor to the point where the laser strikes the tape measure, **RECORD**.

Move to the center point of the rear wheel of vehicle and measure the point where the laser strikes the tape measure, **RECORD**.

If the measurements at the front and rear wheels are not equal, the bay has a slope.

Rotate the floor slope handle on rear wheel until equal measurements are registered at the front and rear wheels.



NOTE: When rotating eccentric axle on **SCA 1 ISOColor**, both measurements will change at front and rear vehicle wheels, to achieve equal measurements, more than one eccentric axle adjustment may be required.

Note the number on the floor slope gauge and record that number along with the bay designate on floor slope sticker provided. Repeat procedure for other bays and record.

NOTE: After measurements have been taken, remove laser and store in a secure place

FLOOR SLOPE REGISTRY

<i>Bay#</i>	<i>Slope</i>	<i>Date</i>	<i>Bay#</i>	<i>Slope</i>	<i>Date</i>

3.3 VEHICLE PREPARATION

- Remove ice or mud from under the fenders.
- Set the tire inflation to the values recommended by the manufacturer.
- See that there is no load in the vehicle unusual to normal driving conditions.
- Check vehicle springs for sag or broken leafs.
- Check function of any automatic leveling systems and specific manufacturers instructions pertaining to vehicle preparation for headlamp alignment.
- Clean lenses (foggy and or yellowed lens can lessen the lamp intensity by up to 80%), check for bulb burnout, broken mechanical aiming pads, moisture in lens and proper beam switching.
- Stabilize suspension by rocking vehicle sideways.

4. HEADLAMP ALIGNMENT

4.1 ALIGNMENT OF OPTICAL HEAD TO VEHICLE

Place the **SCA 1 ISOColor** in front of the first headlamp to be aligned. Once the **SCA 1 ISOColor** is in place, the lens of the optical head should be approximately 12 inches (+/- 6 inches) from the face of the headlamp.

Set the floor slope of the eccentric wheel for the bay in which the vehicle has been parked.

Rotate the sighting unit so that the front of the vehicle can be seen through the sighting unit. Locate two (2) common points on or under the hood to align the line in the sighting unit on.

NOTE: Points can be hood stops, radiator support (s), points of fender, etc.

While looking through the sighting unit, align the line of the sighting unit on the two common points by rotating the optical head of the machine.

The **SCA 1 ISOColor** is now aligned with the vehicle. Repeat the alignment process for each lamp.

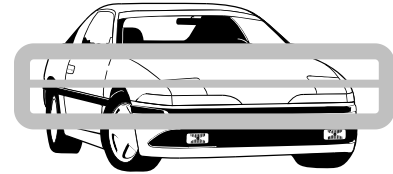
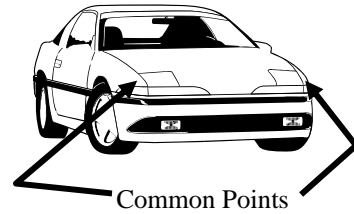

4.2 CENTERING on the HEADLAMP

Turn headlamps on. Move optical head up, or down to the center of the headlamp. Position of center of the headlamp is approximate; a $\pm 1.5''$ allowance is acceptable.

TRICK: A method of determining if position is greater than 1.5" is by observing the illumination that appears on the front of the optical lens housing when moving the optical head left/right and up/down. Position aimer until illumination is of equal proportion around lens.

4.3 SELECTING HEADLAMP PATTERN

Not all headlamps are created alike and different vehicles may have different design patterns. To be certain of the lamp pattern, a designate is located on the lamp at the bottom of the lens. Patterns of lamps that may be aligned with the **SCA 1 ISOColor** are;

- **SAE HIGH BEAM:** All high beam lamps. Highest intensity point is centered on the Horizontal / Vertical axis.
- **SAE LOW BEAM:** All low beam lamps manufactured prior to 1999, selective manufacture after 1999. The high intensity area is located in the lower right hand quadrant.
- **FOG/DRIVING LAMPS:** All fog/driving lamps the top of the high intensity area is located 4" down and centered on the Vertical axis.
- **SAE LOW BEAM "VOR"** (Visual Optical Right): Low beam lamps manufactured after 1999, some vehicles. The high intensity area is located in the lower right hand quadrant and the beam pattern is aligned by placing the right upper portion of the beam pattern on the Horizontal axis.

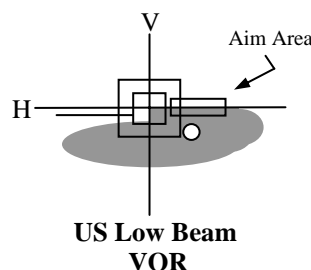
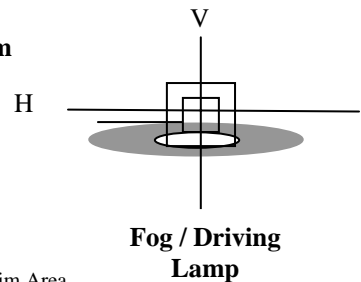
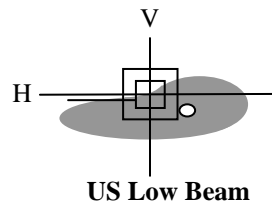
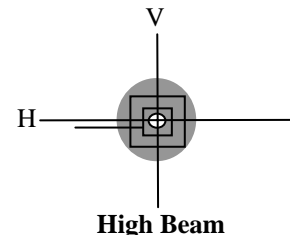

- SAE LOW BEAM “VOL” (Visual Optical Left): Low beam lamps manufactured after 1999, some vehicles. The high intensity area is located in the lower right hand quadrant and the beam pattern is aligned by placing the left upper portion of the beam pattern on the .4 Degree (2.096”) Down Horizontal axis.

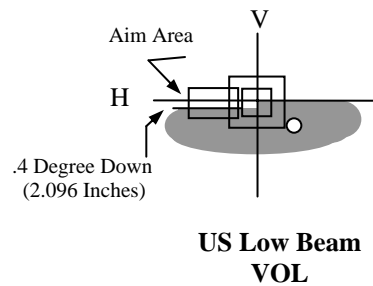

- HID (High Intensity Discharge / Xenon) Lamps
Some HID / Xenon lamps (*bright and bluish in appearance*) generate minimal Infrared emission to activate the ISOColor screen, visual appearance of pattern on screen may have only one color and possibly no color. However, a representative visual alignment is achieved by observing the lamp pattern as depicted on the screen and aligning it to the appropriate position. In the event of only one, or two colors appearing on screen, the center of the inner most color represents the hot spot.

4.4 ALIGNMENT OF HEADLAMP PROCEDURE

1. Locate **SCA 1 ISOColor** approximately 12 inches from in front of the lamp to be aligned. Placement can be 6” to 18” without jeopardizing alignment.
2. Position **SCA 1 ISOColor** in front of first lamp to be aligned. Centering of system on headlamp is very forgiving, as the fresnel lens provides a ± 1.5 ” widow for centering.
3. Align **SCA 1 ISOColor** to vehicle by sighting through the sighting unit and rotating optical head until line in sighting unit intersects the two common points selected.
4. Headlamps should be switched on to low beam as this is the primary driving lamp.
 - a. In compound lamps, where the Low Beam and the High Beam are in the same lamp, you only align one pattern, as by law, the other pattern must be within 1.5” of perfect alignment.
5. While viewing aim screen, adjust headlamp to position that appears as graphic illustration of headlamp pattern selected. The most inner portion of color is the high intensity zone and this is what you center over the white dot designated for the lamp pattern selected.

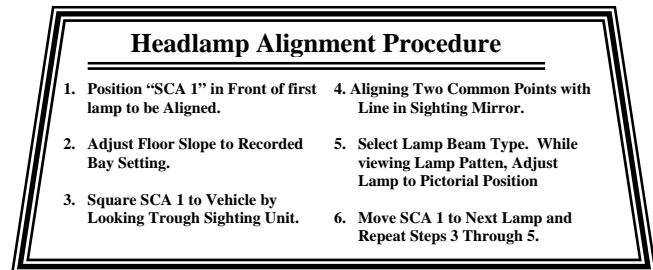

- i. NOTE: Graphics on aiming screen denote position of lamp position in inches.
- ii. Outer box denotes 8 inches, inner box denotes 4 inches. Each hash mark denotes 1 inch increment.

6. Repeat steps for remaining lamps.

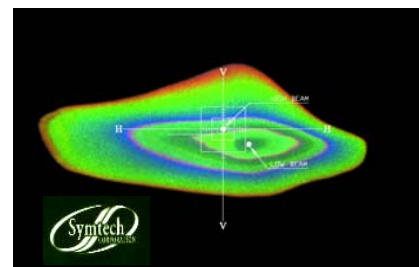

5. LASER CALIBRATION / MAINTENANCE

5.1 FLOOR SLOPE LASER CALIBRATION

“LASER IS CALIBRATED AT THE FACTORY PRIOR TO SHIPMENT”

“Calibration Required ONLY if Rear- LASER Adjustment Set Screw has been tampered with”

Tools Required: **Elevated Surface** (wheel alignment, frame machine, etc.)

Level (carpenters level or other means)

6’ Straight Edge (board or other means)

5/64” Allen Wrench

Locate an elevated surface and lay the straight edge on surface facing away from optical head. Check straight edge for level, shim if necessary.

Move **SCA 1 ISOColor** to end of straight edge, turn on the laser and adjust height of optical head so that the mounted laser will shoot down the straight edge.

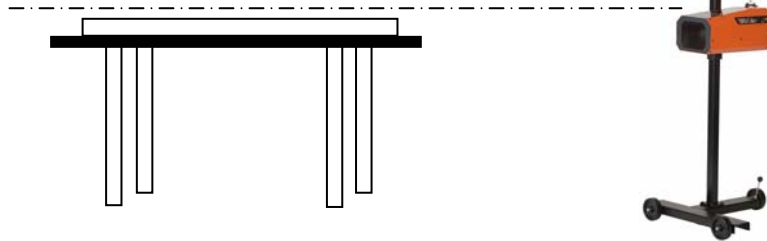

Adjust the rear floor slope wheel until the level in the optical head is centered. Readjustment of height of optical block may be necessary.

Adjust the rear height adjustment set screw of the laser assembly (Lock Tight has been installed on screw at factory, minor pressure should break seal) till laser is viewed at both ends of straight edge equally.

Laser is now calibrated, installing lock tight or other adhesive to adjustment screw is recommended.

5.2 MAINTENANCE

The **SCA 1 ISOColor** will provide years of trouble free operation with minimum maintenance, however, care should be taken in the day-to-day usage of this service instrument. Following are areas that should be periodically checked and serviced;

- Check wheel axles nuts for tightness, minor lubrication is recommended.
- Check the optical head mounting bolts for tightness and tighten as required.
- Check all other mounting screws, bolts and nuts for tightness.
- Clean the mast area where the brake rides with a mild detergent to assure of secure holding.
- Clean the front lens, sighting unit and viewing window with a mild detergent being careful to use a non-abrasive soft cloth.
- Visually inspect alignment screen for burn holes that could have been caused by exposure to direct sunlight. Caution should always be exercised in storing of SCA 1, a placement of a dust cover (P/N: 01016000) on unit is recommended during storage.

6. FREQUENTLY ASKED QUESTIONS

Question: Level in optical head is not centered during alignment procedure?

Answer: Level vial is used ONLY when checking the calibration of the **FLOOR SLOPE LASER**.

Question: The high intensity (hot spot) area of one headlamp is of a different color than the other lamp?

Answer: All lamps are legislated to be created equal, but this has proven not to be the case. Lamp intensities will vary from lamp to lamp. The intensity of the lamp will determine the color of the high intensity zone.

Question: Do I have to check for floor slope every time I perform a headlamp alignment?

Answer: Floor slope need only be performed one time in each bay that the **SCA 1 ISOColor** is to be used. When determining the floor slope, record the reading of the rear eccentric wheel on the sticker provided, Each time you are in that bay, refer to the sticker and adjust the rear eccentric to that measurement.

Question: Must I re-calibrate the Sighting Unit when I move the mounting of the sighting unit for taller, or shorter technicians?

Answer: YES. It is good operating procedure to always check the Sight Unit calibration prior to all headlamp alignments. When different height technicians are using the system, re-calibration is sometimes required when moving the mounting of the sight unit from a high to low position and vice-versa.

Question: I cannot attain equal readings at the front wheel and the rear wheel areas when determining the floor slope.

Answer: The only time that this can occur is when the shop bay has an abnormally excessive angle of slope. The most frequent problem with determining floor slope is patience in adjusting until the measurements are equal. A TRICK to assist in making this measurement is to first measure the height of the laser at the optical head. Then turn the eccentric wheel until the laser reading matches the measurement of the optical head at the rear wheel area. Check readings at front and rear wheel areas and make, if any, minor adjustments to equal measurements. RECORD READING OF ECCENTRIC WHEEL FOR FUTURE REFERENCE.

Question: What do I use as reference when squaring the SCA 1 ISOColor to the vehicle and do I need to square again when moving from one lamp to another?

Answer: It is always recommended to check the alignment of the sight unit to the vehicle for every lamp to be aligned. Some reference points that are prominent on most vehicles are the grill, hood line, radiator support, hood bumpers, strut tower bolts and common assembly point bolts. Always pick two points that are of equal proportion.

Question: Why is the aim screen not as colorful when I align Xenon headlamps?

Answer: Xenon lamps do not generate the IR (infra-red) of incandescent lamps and therefore less color will appear on screen. In most instances, a minimal amount of color will appear and that is the high intensity zone (hot spot) of the lamp. If no color appears at all, then alignment should be performed by viewing the overall pattern of the lamp and positioning it as the illustration of lamp patterns notes on pages 7. and 8..

WARRANTY

All **Symtech Corporation** products are warranted to be free from defects in material and workmanship under normal user service for a period of one year after the sale of the product. Exception to this policy will be individually evaluated and must be approved by **Symtech** Corporate. The sole obligation under this warranty shall be to repair, or replace any defective products or parts thereof, which upon examination are deemed to the seller's satisfaction to be defective.

The warranty shall not apply to any product, which has been subject to misuse, negligence, or accident. The seller shall not be responsible for any special or consequential damages and the warranty as set forth is in lieu of all other warranties, either expressed or implied. However, the seller makes no warranty of merchantability in respect to any products for any particular purpose other than that stated in literature and any applicable manufacturer shop or service manuals referred to therein, including any subsequent service bulletins.

All Symtech Corporation Optical Headlamp Alignment Systems have been tested by an AMECA accredited independent laboratory and found to comply with the Society of Automotive Engineers (SAE) recommended practices prescribed in standards j599, j600, j1383 and j1735.

The seller makes no claims or warranties of any kind that the Symtech Corporation Optical Headlamp Alignment Systems will align headlamps that do not conform to Society of Automotive Engineers recommended practices described in j599, j600, j1383, and j1735.

